

decomagazine

THINK PARTS THINK TORNOS

72 01/15 ENGLISH

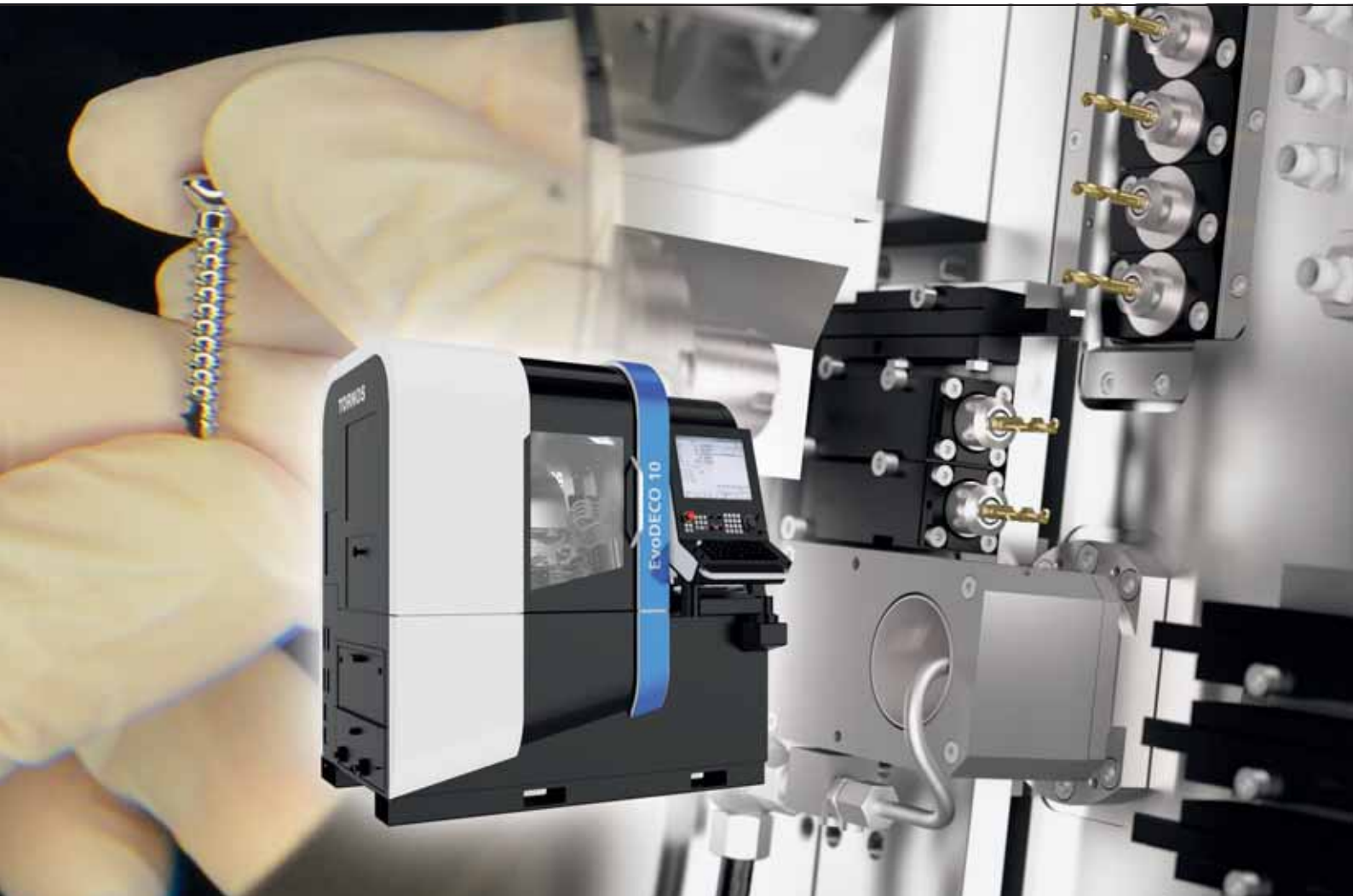

Swiss GT 13:
a winning
combination



Opening up
new markets with
the SwissNano



EvoDeco
in the service
of health



Success story
with the
Tornos CT 20

UTILIS
multidec[®]
swiss type tools

**PRECISION TOOLS
FOR THE MICROMECHANICAL AND
THE MEDICAL INDUSTRY**



UTILIS[®]
Tooling for High Technology

■ **Utilis AG, Precision Tools**
Kreuzlingerstrasse 22, 8555 Müllheim, Switzerland
Phone +41 52 762 62 62, Fax +41 52 762 62 00
info@utilis.com, www.utilis.com

7

15

32

46

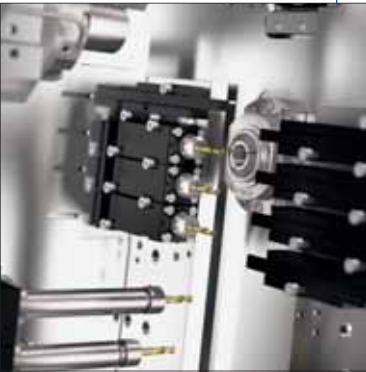

New design for even more functions



Options to boost the capabilities of the BA 1008



A hotly anticipated event



Diba Industries eliminates bottleneck with Tornos

IMPRESSUM

Circulation: 16'000 copies
Available in: Chinese/English/
French/German/Italian/Portuguese
for Brazil/Spanish/Swedish

TORNOS SA
Rue Industrielle 111
CH-2740 Moutier
www.tornos.com
Phone ++41 (0)32 494 44 44
Fax ++41 (0)32 494 49 07

Editing Manager:
Brice Renggli
renggli.b@tornos.com

Publishing advisor:
Pierre-Yves Kohler

Graphic & Desktop Publishing:
Claude Mayerat
CH-2830 Courrendlin
Phone ++41 (0)79 689 28 45

Printer: AVD GOLDACH AG
CH-9403 Goldach
Phone ++41 (0)71 844 94 44

Contact:
plumez.j@tornos.com
www.decomag.ch

SUMMARY

Dear Reader	5
New design for even more functions	7
Swiss GT 13: a winning combination	11
Options to boost the capabilities of the BA 1008	15
New machine control software releases	21
All small parts on the MultiSwiss	23
An increasing range of functions with TISIS	25
Opening up new markets with the SwissNano	28
A hotly anticipated event	32
EvoDeco in the service of health	35
Extraordinary expertise	39
Success story with the Tornos CT 20	43
Diba Industries eliminates bottleneck with Tornos	46
Refill it! Motorex Mini Sprays	49

NEW SPINDLE CENTERING SYSTEM MAKES YOUR LIFE EASIER!



HIGH PRECISION – FAST – SMART
VIDEO ► www.wibemo-mowidec.ch

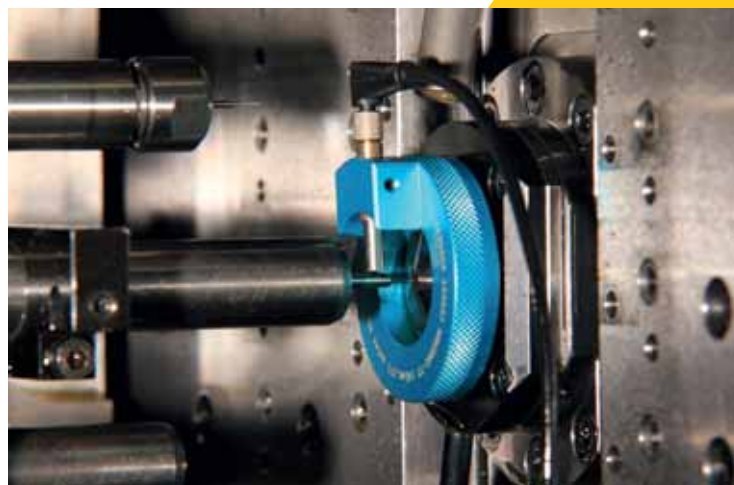

DEAR READER,

The first three months of the year are upon us and I would therefore like to take this opportunity to reflect briefly on the past once again. Last year was undoubtedly a milestone in the history of Tornos. In only the second year after launching the strategic reorientation, which aimed to increase the internationalisation of the Group as a matter of critical importance, we introduced the first two Swiss-type lathes for the standard segment – the CT 20 and the Swiss GT 26 – following the opening of the new Tornos Xi’an factory in China last autumn.

Tornos and standard machines: Do they go together? Yes, they do! Tornos has worked on developing Swiss-type lathes for over 100 years and has established itself as a pioneer in turning technology throughout the world. With its capacity for innovation, Tornos has succeeded time and again in launching new products in the high-end area, introducing trends that have ultimately become standards.

It is therefore only logical that we are now also transferring our many years of experience in manufacturing cutting-edge technology to our own products which, thanks to their versatility, precision and robustness, are intended to address a broader customer base. This is where we rely on using key components that are manufactured in Switzerland. Only by using these parts can we guarantee that our new machines will meet our very high internal requirements and be certain that the “heart” – and thus the engineering skills and knowledge – can be clearly identified as belonging to Tornos.

In this edition of the decomag, we will present you with the latest products from Tornos: The EvoDeco 10 and 16 (page 7), both with a completely new design and many improvements; and the



Swiss GT 13 (page 11), already the second product in the GT series. In addition, our MultiSwiss (page 23) and Almac BA 1008 (page 15) machines will provide you with new options in the area of machining.

We always strive to offer our customers added value with all of our products. No matter whether they are manufactured in Switzerland or in Asia, or whether the customer focuses on complexity, quality or productivity – we offer a solution which adapts to the needs of our customers.

I hope that this edition of decomagazine will inspire you.

Michael Hauser
CEO



HAROLD HABEGGER

Canons de guidage Führungsbüchsen Guide bushes



Type / Typ CNC

- Canon non tournant, à galets en métal dur
- Évite le grippage axial
- *Nicht drehende Führungsbüchse, mit Hartmetallrollen*
- *Vermeidet das axiale Festsitzen*
- Non revolving bush, with carbide rollers
- Avoids any axial seizing-up



Type / Typ C

- Réglable par l'avant, version courte
- Longueur de chute réduite
- *Von vorne eingestellt, kurze Version*
- *Verkürzte Reststücke*
- Adjusted from the front side, short version
- Reduced end piece

Type / Typ TP

- Réglage par un vérin pneumatique
- 3 positions: travail-serrage-ouverte
- *Einstellung durch einen pneumatischen Zylinder*
- 3 Positionen: Arbeitsposition-Spannposition-offene Position
- Adjustment by a pneumatic cylinder
- 3 Positions: working-clamping-open

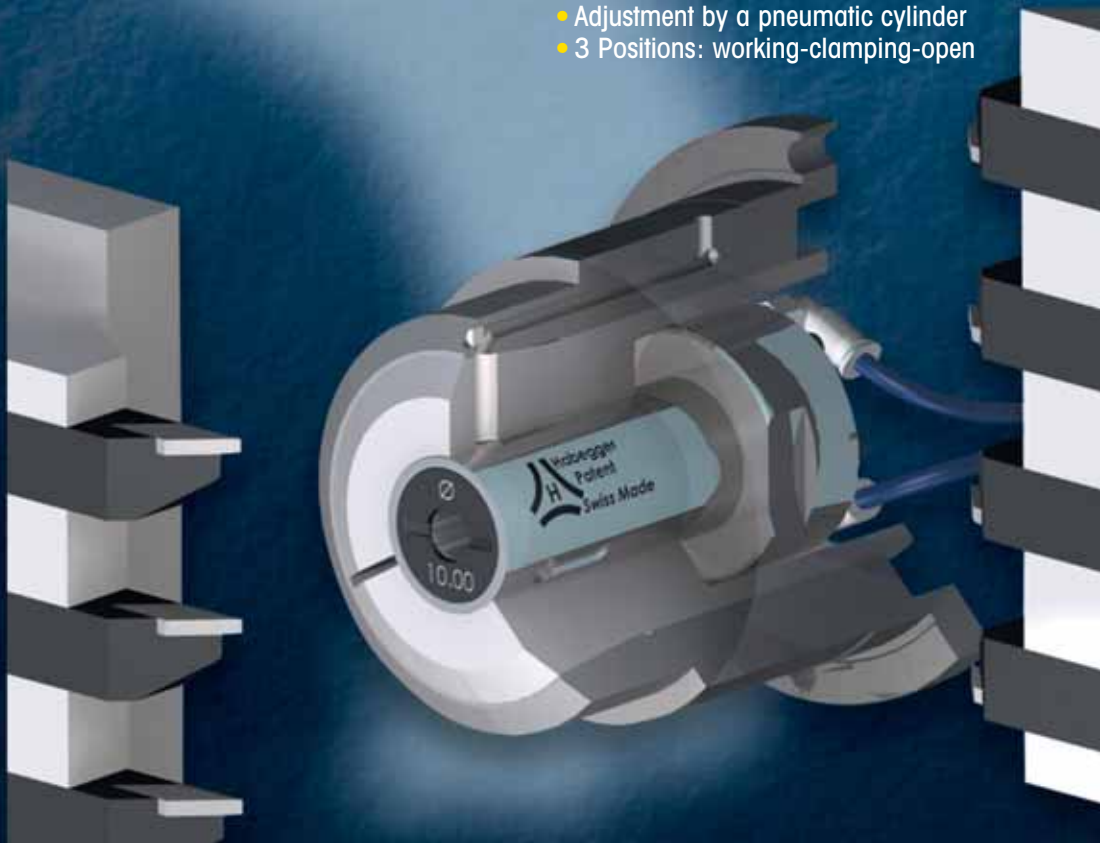

- ▶▶▶ 1 Porte-canon: 3 types de canon Habegger!
- ▶▶▶ 1 Büchsenhalter: 3 Habegger Büchsentypen!
- ▶▶▶ 1 Bushholder: 3 Habegger guide bush types!



NEW DESIGN FOR EVEN MORE FUNCTIONS

**EvoDeco machines continue to meet the needs of the most demanding bar-turners with ease!
Already recognised as highly advanced, this platform is undergoing constant improvement.**



During the Journées Horlogères open days, Tornos will unveil a complete overhaul of these iconic machines. decomag wanted to find out more and met with Massimo Tidei, project manager, and Philippe Charles, product manager, both of whom work for Tornos.

The fastest machines on the market

"EvoDeco machines are equipped with the best kinematics on the market: no other current solution is able to offer the same level of performance and sophistication as an EvoDeco. It was of crucial importance that we kept ahead of the market in this way, as it is vital to Tornos and to our customers, who need to be the best in their field! The perfor-

mance of our machines is mirrored by the success to our customers", notes Philippe Charles. He adds: "Over the last 15 years, we have been constantly improving these products". Today, the EvoDeco platform is used to create an impressive array of parts, thanks in particular to the broad range of options and accessories available.

Fundamental improvements

As for the EvoDeco 32, the base of the two machines has been overhauled with the aim of improving the temperature response and the maintenance and servicing operations. *"In fact, since the trend is towards a reduction in the size of production runs, it is increasingly important that the first*

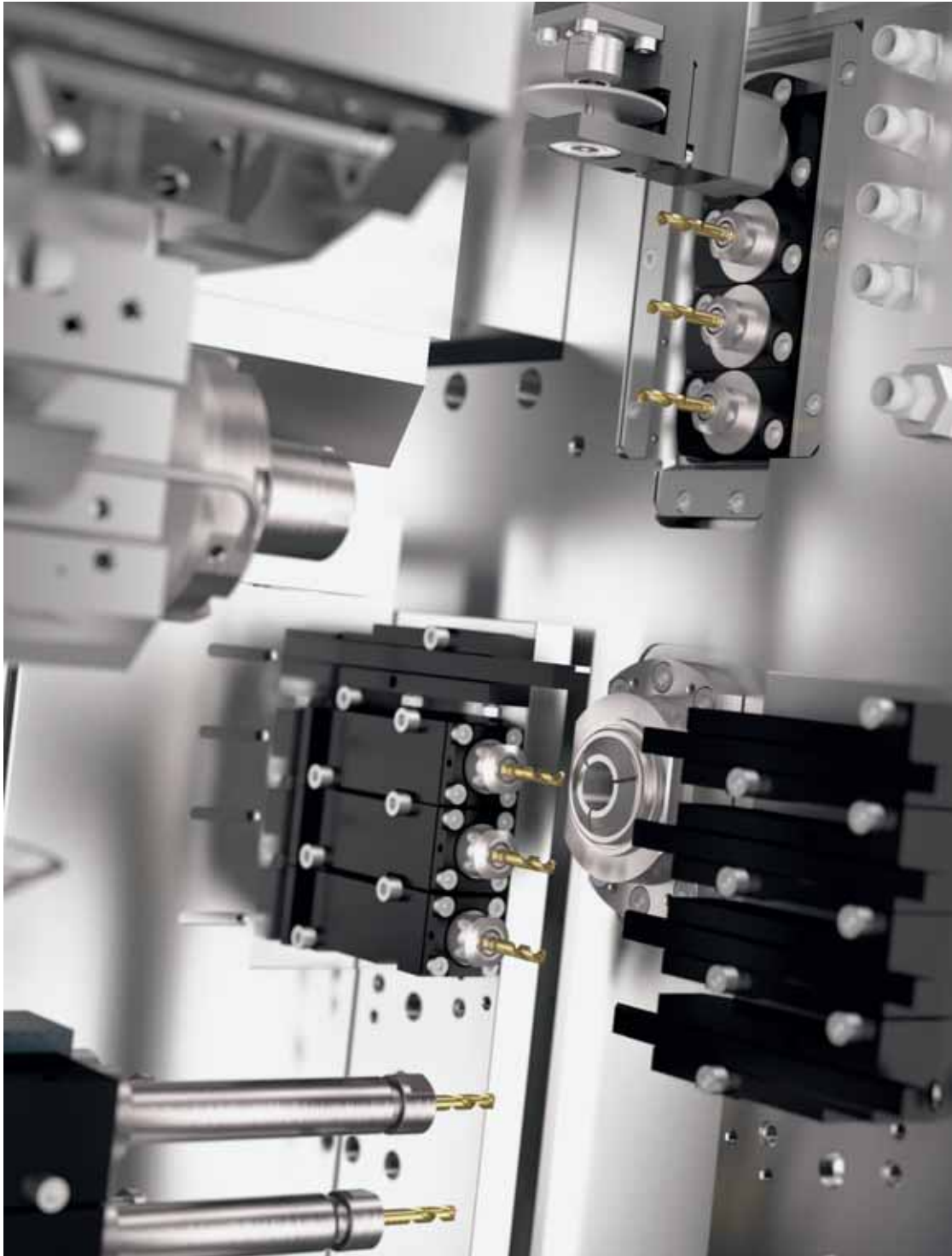

parts are perfect. The machine's thermal system must therefore comprise the shortest possible loops to reduce the warm-up time as much as possible", Massimo Tidei explains. The machine has also been redesigned in terms of rigidity to ensure it offers improved machining performance. The two new *evoDeco* machines are also equipped with cyclical lubrication.

Design and ergonomics

In addition to these improvements, they are housed in a new enclosure which, in addition to improving their appearance, also makes them more ergonomic. It is easy to tell that each machine belongs to the *Tornos* family. Designed for and around the operator, the new machines built by *Tornos* have been developed for optimum user comfort. The

machining area is as large and streamlined as possible to facilitate tool setting. The control set on a pivoting arm provides an effective support to help shorten setup times. It is easy to gain access for maintenance to facilitate servicing procedures and thereby minimise machine downtime.

Two machines, 4 versions

Available in versions with 10 or 8 linear axes, EvoDeco 10 and EvoDeco 16 machines take two C axes as standard. The two turning machines are equipped with synchronous motor powered spindles. This technology, unique on this type of machine, means that the machine's productivity can be increased significantly when machining parts which require frequent spindle stops. The cycle time is reduced by more than 30%! Both machines are equipped with a PC featuring a touchscreen, allowing the operator to program directly on the machine. Of course, they have kept the Deco concept's key features, meaning up to 4 tools can be engaged in the material simultaneously. Both of these machines are completely modular: their base plates can take different types of tool holder.

Custom setup...

The machine can be fine-tuned to suit the part, Mr. Tidei explains: *"With an EvoDeco, the user is guaranteed to be able to position the right tool in the right place, regardless of the part's manufacturing constraints: practically any configuration can be envisaged!"* The machines can be equipped

with either just turning tools, or be transformed into a milling machine by housing mills in all available positions. They are the only machines on the market able to achieve such a feat! Of course, each machine can house different special tool holders, one or even two thread whirling tools, hobbing devices, a polygon tool and high-frequency spindles. Although very closely related, the two EvoDeco machines have their own characteristics.

... for ever better levels of performance

In addition to its highly comprehensive equipment, the EvoDeco 16 machine can, for example, be equipped with a B axis for positioning in back operation, which is particularly useful for creating angled implants for the dental industry. The EvoDeco 10 machine, however, can receive up to 3 hobbing devices, one of which can be used in back operation, making it without doubt the fastest hobbing machine on the market!

EvoDeco 10 and EvoDeco 16 machines are available immediately! Contact your nearest Tornos representative now to discover these two new products.



Tornos SA
Industrielle 111
2740 Moutier
Tel. +41 32 494 44 44
Fax +41 32 494 49 07
www.tornos.com

PIBOMULTI

SWISS



MADE

Jambe Ducommun 18
CH 2400 Le Locle
Tel: +41 32 933 06 33
Fax: +41 32 933 06 30

www.pibomulti.com
info@pibomulti.com

PIBOTURN - PIBOTRIFLEX

The turning tool-holder of the future

PIBOTURN High precision modular turning holder

Système breveté

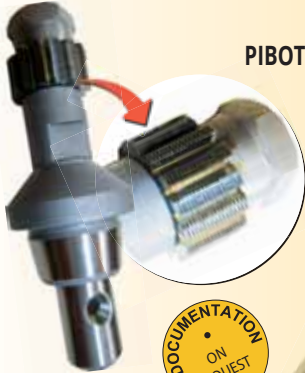

PIBOTRIFLEX High precision modular tool holder



Milling Holder, simple and precise fine adjustment, required precision < 0.002 mm



BMRB 0.20

Specific equipment and accessories for TORNOS machines



Rotation 0.002 mm



High precision gear cutting

Adjustable angle head with range of adjustability from 0 to 90°
5 mm clamping capacity

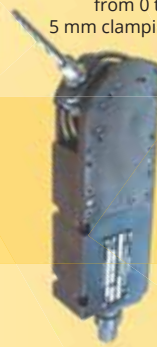

Polyvalent drilling and milling head for heavy machining with speed-reducer Usable with or without over-arm



ASK FOR OUR FULL RANGE CATALOGUE !



Right angle spindle speeder
5 mm clamping capacity
15'000 rpm



Modular tool holder

Whirling machine 27°



150130EN

DIXI polytool

Tungsten carbide and diamond precision tools



DIXI POLYTOOL S.A.
dixipoly@dixi.ch
www.dixipolytool.com

SWISS GT 13: A WINNING COMBINATION

"The new Swiss GT 13 is the best combination of productivity and high feasibility, to be available on the market" explains Philippe Charles, product manager, by way of introduction during our meeting to find out more about this new machine.



Six months after the Swiss GT 26 turning machine was unveiled, Tornos is expecting to repeat its huge commercial success with the Swiss GT 13 turning machine, the perfect complement to this range of products dedicated to machining moderately complex parts.

Recognised, tried and tested kinematics, boasting numerous machining options

The Swiss GT 13 has taken the kinematics from its big brother, with all the adaptations required for machining parts with the smallest dimensions from bars of 2 to 13 mm. *"This product is perfectly*

adapted to the market's needs and offers high-performance solutions for machining parts for the main markets in which our company holds a leading position" continues the product manager.

The advantages of controlled kinematics

Whether for the electronics, medical/dental, watch-making or subcontracting industry, the version of the kinematics with 5 or 6 linear axes is perfectly adapted to the customer's needs. The 5-axis model is equipped with conventional, well-known kinematics with a platten (axes X1 and Y1) for machining from bars. The platten is modular (a Tornos



advantage) and can take a number of different tool holders or even rotating tools, which may be needed depending on the parts to be machined. The back spindle is fitted on a carriage with cross slides and allows back operations to be carried out 100% in concurrent operation time.

The 6-axis model is equipped with an additional linear numerical axis for back operation, which boasts the advantage of increasing the number of positions and tools whilst facilitating tool setting (numerical centring of tools).

High-performance spindle and counter spindle

The machine is designed as standard to work with or without a rotating guide bush. In less than

15 minutes, the operator can easily switch from one working mode to the other. The main spindle and the motor guide bush can be run at speeds of up to 15,000 rpm. The spindle performance is so great, it can accelerate/decelerate from 0 to 15,000 rpm in less than one second. This increases productivity when machining components which require many transverse operations using the spindle stop, or even the main spindle C axis. Opposite, the back spindle, which is identical in design, offers the same performance in terms of speed, machining and spindle stop time. With 4 kW and 13 Nm of power delivered to each spindle, high performance machining operations can be performed. The 2 spindles are synchronised in phase and angle, which means bar machining operations can be positioned with those carried out as back operations.

A broad range of possibilities...

The basic kinematics for these two configurations is equipped with three motors (two on the platten and one for back operation) to drive the numerous rotating tools. More than 30 tools, including 12 rotating tools, are available.

"Turning, drilling, tapping, milling, polygon operation, internal and external thread-whirling processes, gear hobbing, high-pressure drilling, stamping/broaching, using high-frequency spindles at 80,000 rpm, etc. - virtually anything is possible on the Swiss GT 13 turning machine" claims the product manager. Another advantage is the design,





created to adapt devices with rotating tools. Tornos has developed a tool system which allows a wide choice of units used on different products, such as Swiss ST 26 turning machines. These same devices can also be adapted for main and back operation on the Swiss GT 26 turning machine. *"It is a key benefit for our customers when choosing Tornos products, as this modularity enables them to reduce their investments in tools"* adds Philippe Charles.

Mr. Charles concludes: *"Precision, machining performance, productivity, easy programming, use and setting, all at a very competitive price - these are the benefits offered by the new Swiss GT 13. Don't hesitate in 2015 - come and discover it now"*.

... and flexibility during setup

An entire programme of devices using quick change chucks to save time during tool changing and setting is also available. The unique repeatability of the system, specially developed by W+F for Tornos, allows tools to be repositioned to within a few microns, whilst drastically reducing the setup time. Some of these devices may also feature high-pressure cooling of up to 80 bar, which optimises the machining process and saves time when machining, whilst improving the finish quality.

Accessible programming

Quick and easy programming in standard ISO language combined with the use of the numerical control and the TMI (Tornos Machine Interface) provides all the flexibility customers require. Linked to the TISIS software (see page 25), programming has been further simplified and made more intuitive so that the operator can quickly optimise the parts program.



Tornos SA
Industrielle 111
2740 Moutier
Tel. +41 32 494 44 44
Fax +41 32 494 49 07
www.tornos.com

FORM TOOLS MADE TO YOUR PRINT



GROOVING INSTEAD OF SINGLE POINT TURNING.

AS INDIVIDUAL AS YOUR PART!

- Increase in productivity by up 80 %
- Several systems for cutting width from 3 to 70 mm
- Polish like surface finish quality of the insertable tool
- For use on single spindle, multi-spindle lathes and turning / milling centers

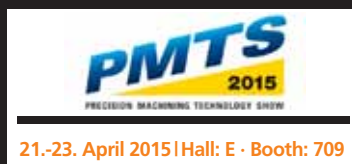

OPTIONS TO BOOST THE CAPABILITIES OF THE BA 1008

Released less than a year ago, the little BA 1008 machine, with a design inspired by the famous SwissNano, enables users working with small prismatic parts to plan new, compact production equipment.



Today, Almac has unveiled new options which will enable the possibilities offered by this compact bar milling machine to be further increased. Let's discover some of them:

Clamping system with parallel jaws

Until now, the BA 1008 machine has been equipped with a collet clamping system, used for machining round or square bars. Almac is pleased to announce a clamping option with parallel jaws which will increase the machine's fields of applications as it can now machine profiled bars with complex shapes to a high level of precision.

How does it work?

Parallel clamping comprises a fixed jaw and a moveable jaw which can clamp and unclamp the profiled

bar to be machined using a pushbar. The jaws are made from tempered steel and are machined using the EDM process to obtain a highly precise form. During a bar feed sequence, the moveable jaw is raised and the profiled bar can move forward without losing its position until it rests in the position defined by contact with the fixed jaw.

Why is a new clamping system needed?

With its F22 collet clamping system, the BA 1008 was only suitable for machining round bars (max. diameter of 16 mm) or square bars (max. 12 mm) requiring the machine to perform a long milling operation on the blank in most cases. This is now no longer the case as the parallel jaw clamping system enables the machine to work with profiled bars already shaped like the blank for the part to be produced.

Presentation

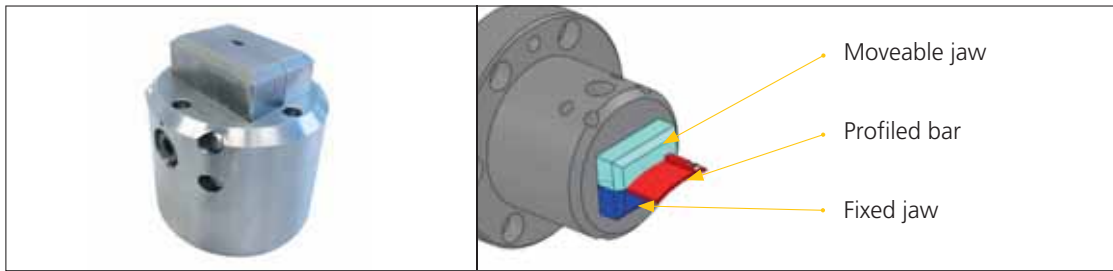

Even greater precision...

Having a fixed jaw gives a contact surface for the profiled section, ensuring that the bar accurately retains its position. This means that when the machine unclamps the bar to feed it forward, it remains in position, and its axis does not shift. This is not the case with standard clamping as, when the collet unclamps the bar, it becomes misaligned and loses its absolute position. This system also allows certain machining operations to be carried out on lengths of bar corresponding to several parts, whilst maintaining optimum precision. The cycle time is reduced as a result, as the need for tool changes is drastically reduced.

Another advantage of this set of jaws is that the size of the opening can be controlled when unclamping the workpiece. The opening can be made as small as possible to minimise the ingress of swarf and oil into the clamping system. This is not the case with the collet clamping system which is either open or closed.

Less swarf and more productivity

In addition to the advantages of precise bar positioning, parallel jaw clamping and the ability to machine profiled bars enable the amount of swarf

and the production cycle time to be reduced. This is because the operator does not have to mill the blank which, along with sectioning, is one of the stages which produces the most swarf and has the longest production cycle.

Optimising the quantity of swarf is particularly useful for applications which require machining precious metals, where being able to recover the swarf is crucial. This is particularly pertinent for watchmaking applications such as, for example, machining gold appliques and links.

Reducing the cycle time is also a key benefit as it means investments can be optimised. Depending on the complexity of the part to be produced and the shape of the blank, the gain in productivity can be up to 50%.

Machining multiple bars with a multi-spindle machine

Parallel jaw clamping also makes it possible to machine multiple bars by, for example, machining two bar shapes in the set of jaws. This means savings can be made both with tool changes (1 tool change for 2 workpieces) and during the sectioning stage as the machine can section both workpieces at the same time.

	Collet clamping, round or square bar	Parallel jaw clamping
Precision	Very good machining precision	Very good machining precision and repositioning of the bar after an unclamping/clamping cycle
Productivity	Good productivity	Very good productivity (no milling of blanks)
Quantity of swarf	Depending on parts machined	Very low quantity of swarf
Multiple bars	NO	YES

Also, the quicker the cycle time, the better the productivity when machining multiple bars. Productivity increases twofold for a workpiece with a cycle time of 10 seconds.

A modular system

Another advantage of this new option is its modularity: not only are the jaws easily interchangeable, but the user can also easily switch from a collet clamping system to a parallel jaw clamping system. Mr. Goy, Setup Technician at Almac, explained that it only takes 30 minutes to change the jaws and 90 minutes to switch from one clamping system to the other.

This means it is very quick and easy for a user who needs to produce several types of part on one production tool to change the run. A undeniable advantage for the BA 1008. The parallel jaw clamping system is available from September 2014 and it is possible to retrofit it to machines already in production. If you would like more information, please do not hesitate to contact your nearest Almac representative.

LET'S DISCOVER THE SECOND NEW FEATURE:

Bar loader for BA 1008

Here is what the Almac BA 1008 machining centre has been missing: a compact, high-performance bar feeder. From December 2014, the Almac machining centre can be equipped with an automatic LNS Quick Load QLS 80 S2 feeder for short bars.

A compact feeder with great autonomy

With its compact dimensions and ability to load bars from 6 to 80 mm in diameter and a length of 1600 mm, the Quick Load was the perfect candidate for equipping the BA 1008 machine.

The feeder has a loading capacity of 650 mm, which allows the BA 1008 to automatically machine around fifty bars of 12 mm in diameter. It allows the production tool to run 24/7, with the least possible intervention from the operator. This option fully optimises the production costs of the BA 1008.

The maximum total footprint of the machine and its feeder is 5300 mm x 1400 mm x 1650 mm, which undeniably makes it a comprehensive yet compact production tool.

Simple to use

The bar feeder is equipped with an intuitive command which also allows diameters and runs to be

PROFESSIONAL TOOLS
- FROM SPECIALISTS
- FOR EXPERTS



NEW GENERATION MICRO END MILLS

- Corner radius of 0,02 - 0,03 mm
- Reinforced cutting edge
- Newest coating technology

www.zecha.de

Presentation



changed in record time. It is also fitted with a device which moves lengthways, allowing technicians easy access to the electrical and pneumatics cabinet located at the rear of the machine. This simplifies movement of the bar loader without any loss of precision.

Availability

The feeder is now available for the BA 1008 and it is possible to retrofit it to machines which are already in service. Please do not hesitate to contact your Almac representative for any further information.

Almac is also working towards integrating this type of feeder into its CU 2007/3007 machines, a development that Decomag will be sure to cover for you.

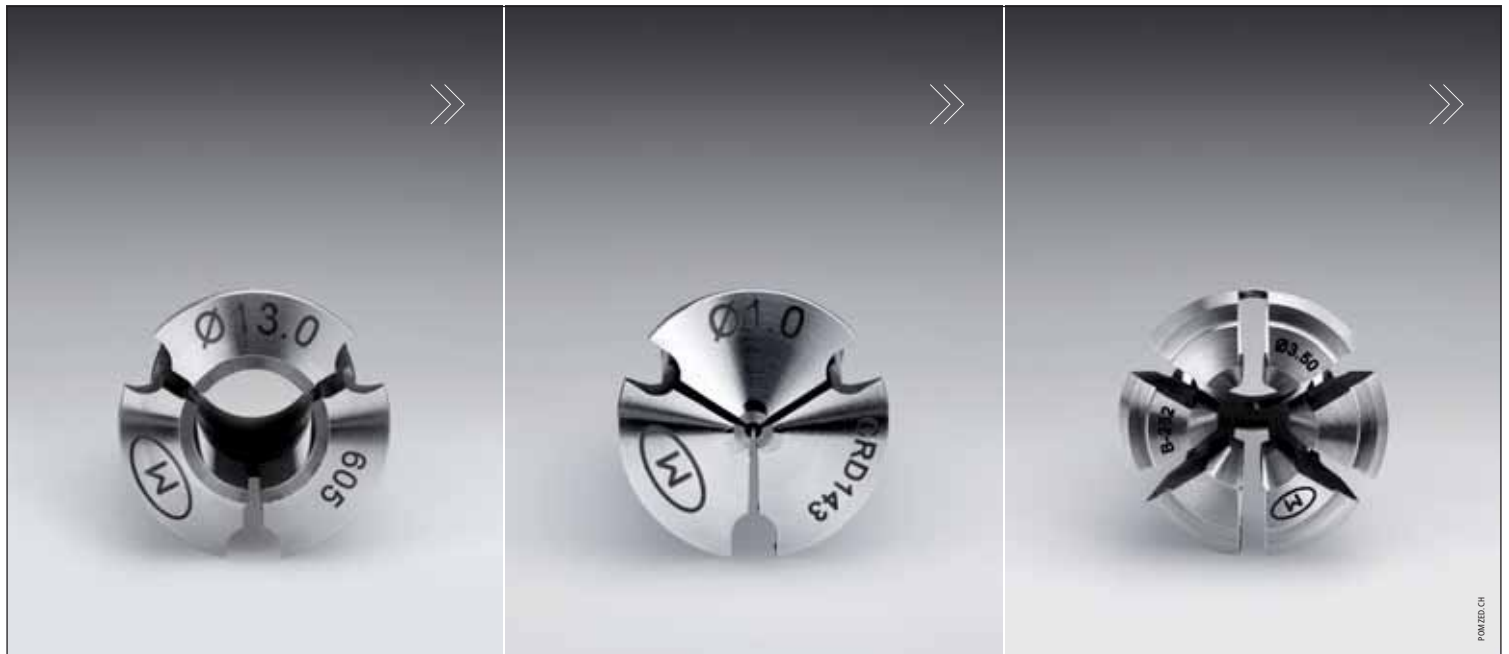

POWZEL.CH

ROUTE DE CHALUET 8
CH-2738 COURT
SWITZERLAND
T +41 32 497 71 20
F +41 32 497 71 29
INFO@MEISTER-SA.CH
WWW.MEISTER-SA.CH



serge meister  **sa**

P R E C I S I O N C A R B I D E T O O L S

THIRD NEW FEATURE

Eco-Pack and Eco-Pack plus: Almac options for saving energy... and money

With the new Eco-Pack and Eco-Pack Plus options, Almac is unveiling new functions to manage the energy consumption of its production tools.



Eco-Pack option: a high-performance standby mode

To reduce energy consumption when the machine has finished production, with the Eco-Pack option,

Almac offers a standby mode for the machine which allows up to 75% of its energy to be saved. It works by automatically switching some of the machine's consumers, such as pumps, the oil mist extractor and even the door locks, to standby.

Eco-Pack plus option: even more possibilities

With the Eco-Pack Plus option, the user benefits from two new functions, in addition to those in the Eco-Pack option. This first is the option to automatically program machine preheating. This allows the operator to start production more quickly, without having to wait for the machine to warm up. The second is the option to program a total shutdown of the machine at the end of production. The electricity consumption is therefore zero whilst the machine is in standby.

The graph below shows a flow chart for these options with the 3 possible modes:

- Without standby (red)
- Standby (light blue)
- Standby and preheating (dark blue)
- Machine shutdown

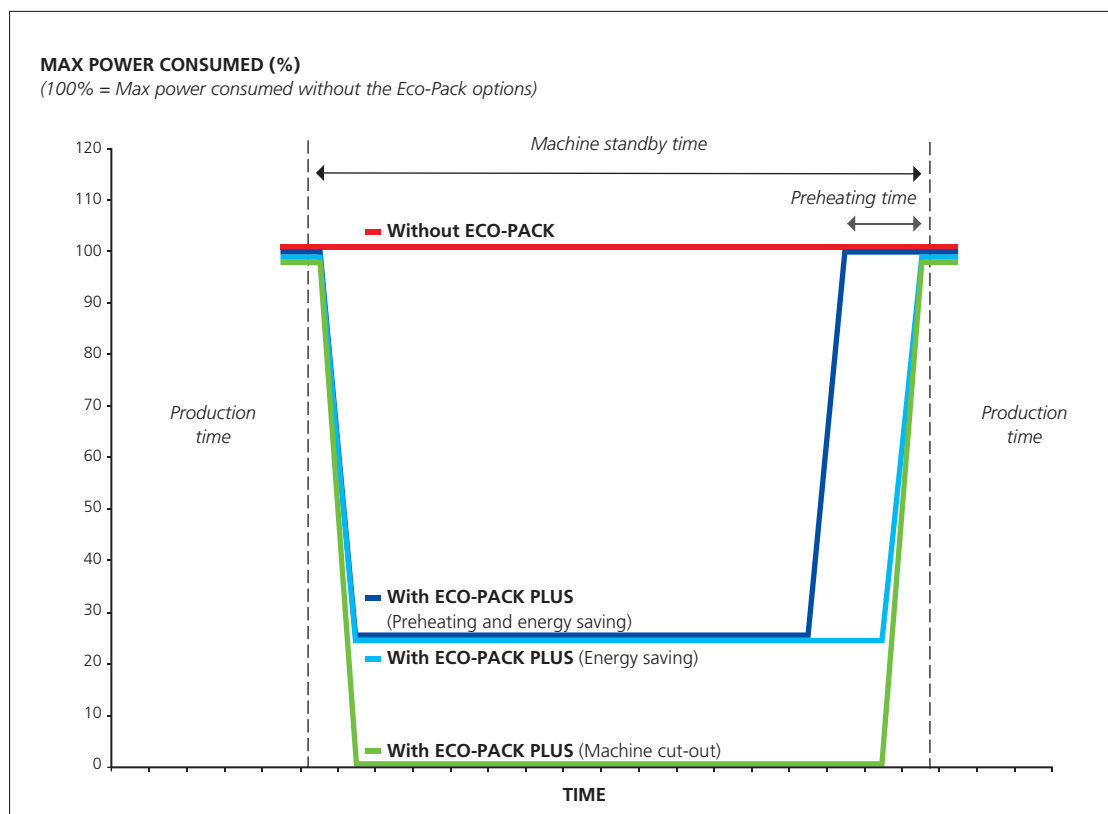

Presentation

A dedicated user interface

Thanks to its dedicated interface, the Eco-Pack and Eco-Pack Plus options are very easy to program. The user can choose the standby mode, plus the date and time for preheating.

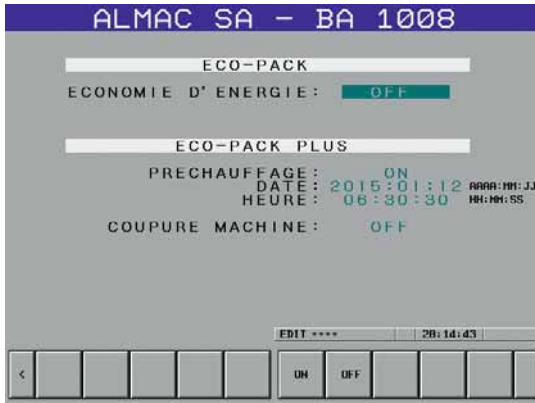

The graph below shows the study carried out by Almac.

Estimation based on:

- Production of 14 hours x 5 days x 50 weeks per year
- Savings of 75% for the Eco-Pack if the machine is on standby
- Savings of 100% for the Eco-Pack Plus if the machine is on standby.
- Price per kWh of € 0.25
- Machine consumption in standby mode, without 1560 W Eco-Pack options

These new options are now available on Almac machining centres. They should appeal to users concerned about environmental issues and mindful of their energy consumption.

Options with quick return on investment

Obviously, the return on investment for options like these depends on both the price per kWh and the production rates. A detailed study must therefore be carried out for each application. We have, however, tried to estimate the return on investment for the Eco-Pack options for a BA 1008 machine as accurately as possible, and the result is clear: we estimate an ROI of 6 months for the Eco-Pack option, with annual savings of 5.7 megawatts and 12 months for the Eco-Pack Plus with annual savings of 7.8 megawatts.



Almac SA
 39, Bd des Eplatures
 CH - 2300 La Chaux-de-Fonds
 Tel.: +41 32 925 35 50
 Fax: +41 32 925 35 60
 www.almac.ch
 info@almac.ch

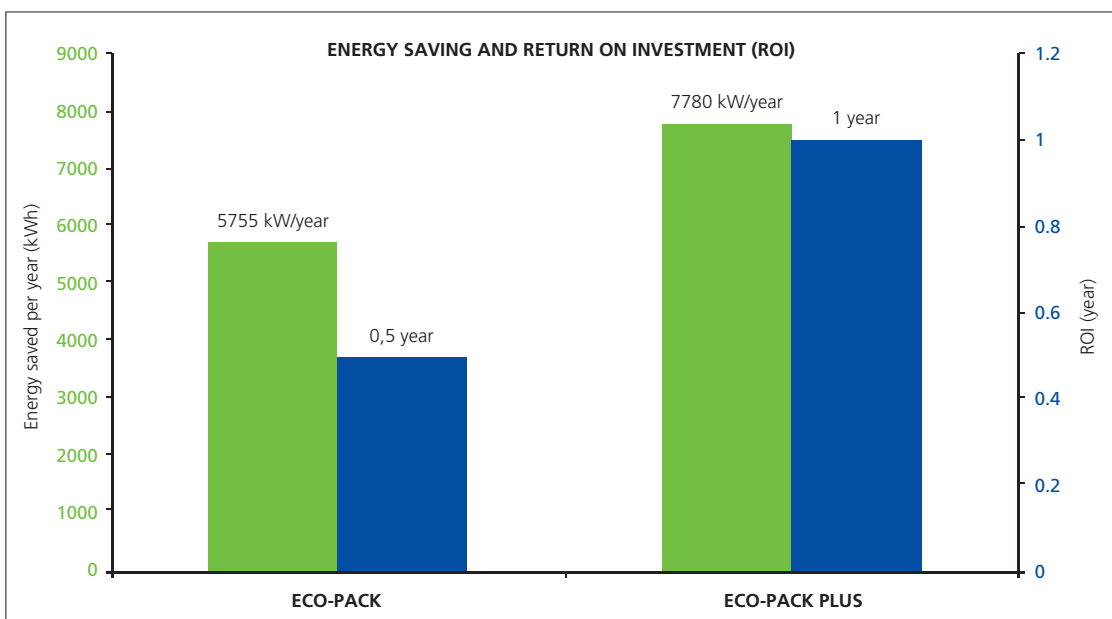



NEW MACHINE CONTROL SOFTWARE RELEASES

The TMI, or Tornos Machine Interface, has made a lot of customers very happy. Its simple, intuitive interface means owners of new machines can benefit from an experience similar to using a smartphone, despite the limited graphic capabilities of a CNC. This year, four versions will be unveiled to ensure the needs of customers are fully met. In future editions, decomag will also be publishing tips and tricks for using the TMI. We look forward to receiving your suggestions.

MACHINE CONTROL SOFTWARE RELEASE SCHEDULE:

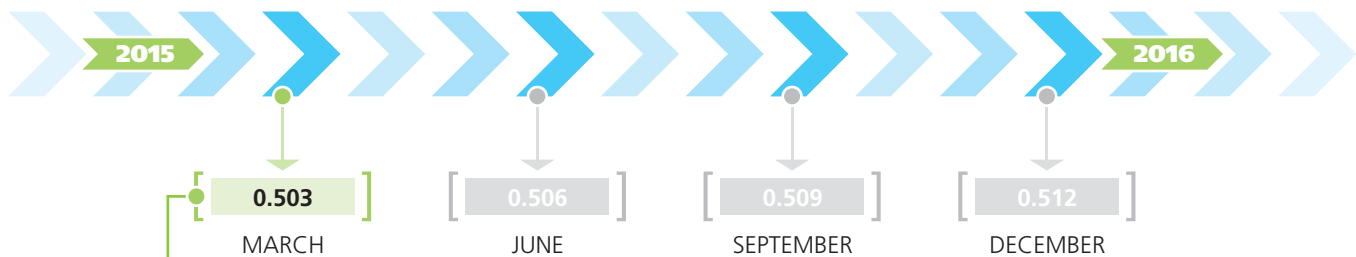

Tornos software version:

- Machine Control: 0503.00
- TB-Deco: 8.02.055
- TISIS: 1.4.3
- Connectivity kit: 1.4.1

New with version 0503.00:

- Tornos CT 20 machine integration
- Tornos Swiss GT 26 machine integration
- Tornos Swiss ST 26 machine integration
- Miscellaneous minor improvements

New developments for 2015:

- Automatic axis lubrication on the SwissNano.
- Connectivity pack for EvoDeco machines.
- Vacuum system management for the SwissNano.
- Help page in TMI.
- New TMI item management.
- Improved production management for the SwissNano.
- And much more.

For the latest news, or to ask questions or make suggestions, contact us at www.tornos.com/softwarecontrol





**FREE
CHOICE!
WITH MAXIMUM
PRODUCTIVITY.**



THE GWS-TOOLING SYSTEM FOR TORNOS MULTISWISS 6X14!

The GWS-tooling system for TORNOS MultiSwiss 6x14 is unique in its design. Profit from the highest cost effectiveness, precision, flexibility and efficiency with GWS.

GWS for TORNOS MultiSwiss: Technological competence comes from Göltebodt!

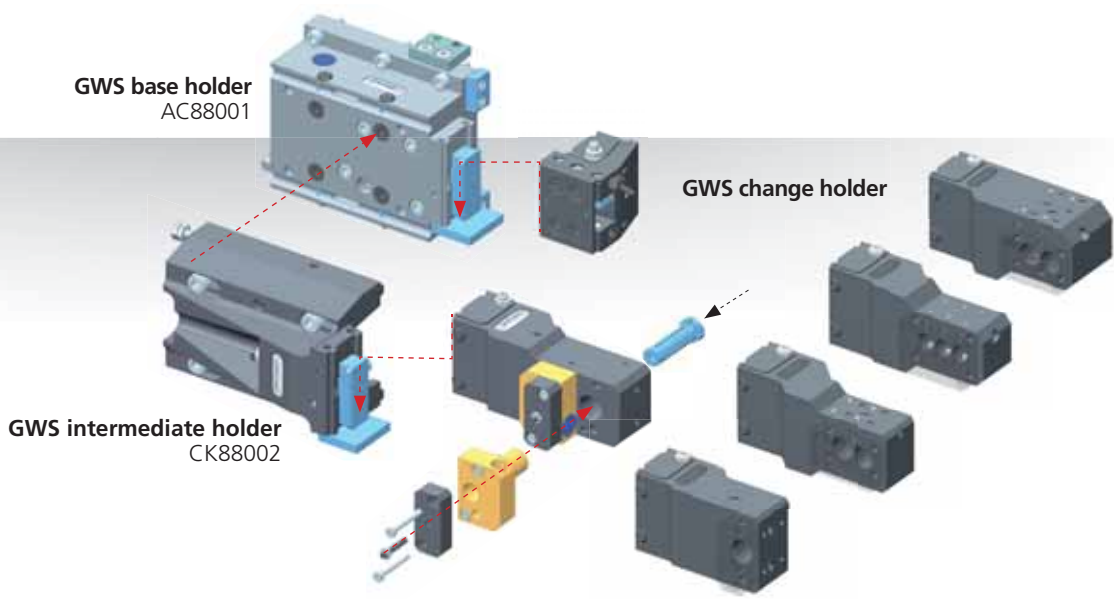



ALL SMALL PARTS ON THE MULTISWISS

Following the success of the MultiSwiss machine in the micromechanics sector, specialists at the company have developed parts outfeed systems better suited to this domain.



One of the problems of removing small parts (especially flat parts) is that they tend to stick to the walls of conventional parts outfeeds, which can be an issue when you need to know exactly which part has been produced on which spindle. *“Our customers have asked us to look into this area, and we are now able to introduce the vacuum system”* explains Rocco Martoccia, Product Manager. To develop these systems on the MultiSwiss, the company has made use of its extensive experience in this field with single-spindle machines. He adds: *“The other concern from our customers was being able to better monitor the production of parts in series by splitting them up into small batches, for example every 30 minutes. If there is an error with a dimension, this avoids having to sort through the entire run.”*

Parts outfeed...

Tornos has developed a relatively simple solution which picks up the parts using a hose, which operates using a venturi system (vacuum-suction) which is connected to the company's compressed air circuit. This system picks up the part in a tube created using new 3D printing technology. *“This allows us to create tubes exactly adapted to the constraints of the parts to be extracted”* explains the manager. The part is propelled towards a synthetic tube in the tray. According to customer requirements, the vacuum outfeed may be adapted to the machine's standard outfeed (internal tray), on a conveyor belt outfeed or on carousel systems.

Presentation

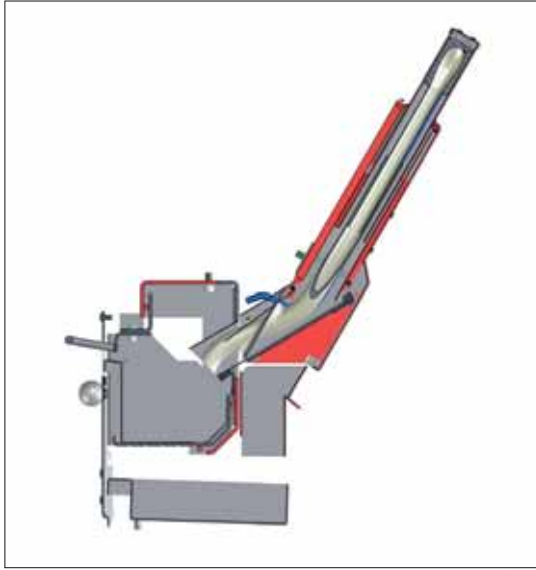

This device can also be used for production configured for parts in the same family, so that the part can be changed automatically (multi-program functionality).

Carousel devices for MultiSwiss

These devices have not yet been accorded an option number. If interested, please contact your usual Tornos distributor.

Availability: Available ex works and can be retrofitted to all MultiSwiss machines

Vacuum parts outfeed for MultiSwiss

This device has not yet been accorded an option number. If interested, please contact your usual Tornos distributor.

Availability: Available ex works and can be retrofitted to all MultiSwiss machines

... with smart management

Depending on the customer's needs, it is possible to send parts to a carousel which comprises several recipients where parts will be deposited. Depending on the autonomy required and the type of parts created, it is possible to select the small internal device or several types of external carousel.

Once the programmed quantity of parts has been reached, the position of the carousel will be indexed and the parts will be deposited in the next tray. The day's production is therefore split into several batches.

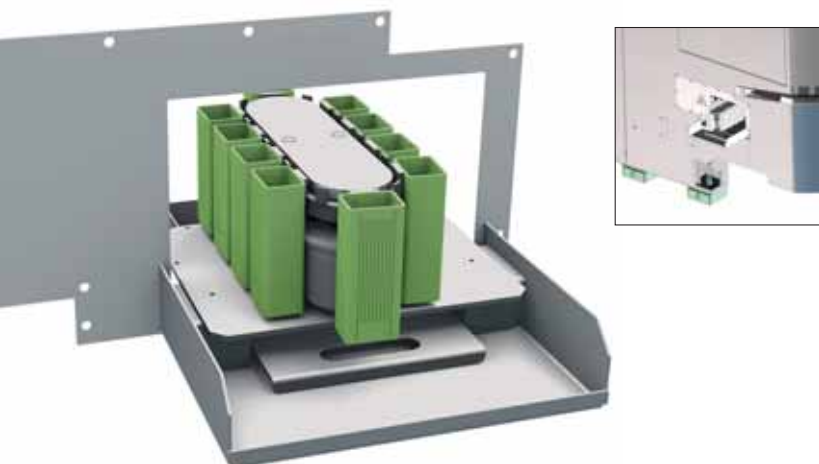
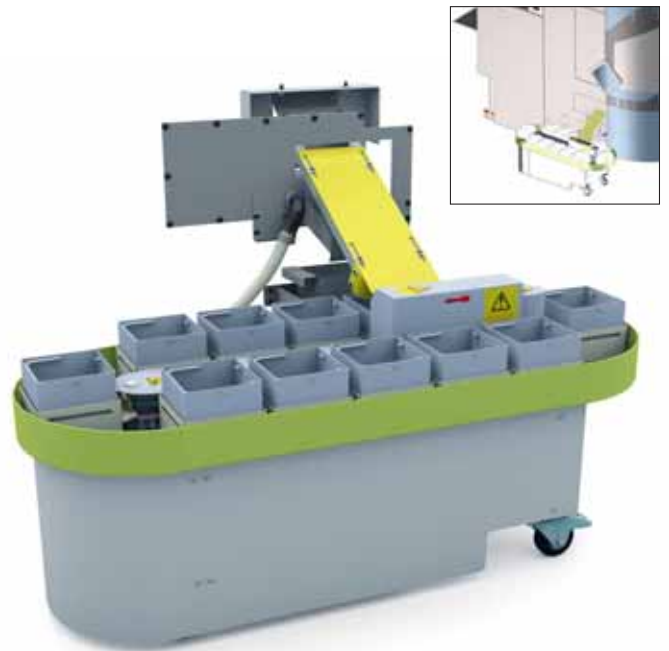

TORNOS

Tornos SA
Industrielle 111
2740 Moutier
Tel. +41 32 494 44 44
Fax +41 32 494 49 07
www.tornos.com



AN INCREASING RANGE OF FUNCTIONS WITH TISIS

The software development teams at Tornos have been working on new functionalities to make the TISIS program even simpler and more intuitive to use.



ISO Codes Assistant

TISIS features a programming help function using assistants for entering ISO codes. The "ISO Assistant" window is displayed using the F12 shortcut key or via a button on the Edit menu bar. This new ISO Assistant window gives a brief description of each ISO code and the optional and compulsory parameters. The data is entered either via the assistant window or from the parts program view.

New Part

TISIS has also had a new window added for the "new part" assistant. All the information for creating a new part is grouped in a single page. A summary of the choices means a simple check can be carried out on the new part to be created.



The present

Swiss GT 13

With the addition of the new Swiss GT 13 machine to the Tornos product range, the company can offer a solution for creating parts which do not require an EvoDeco machine. TISIS is the perfect partner for programming parts on this machine. All programming help functions, from preparing the virtual tool catalogue to supervision and monitoring, are available immediately upon the Swiss GT 13's release.



Integrated help

The new version 1.5 of TISIS is accompanied by an integrated contextual help function, which has 3 distinct sections: 1) General help for using the TISIS software: description of the software's basic functions, 2) Contextual ISO programming help (can be adapted to the type of machine and ISO programming code version); this help works alongside the ISO code assistant, 3) General help for ISO programming with a description of all the codes and options.



TECHNICAL NOTE

When TISIS is used with the connectivity pack, the software updates must be carried out on the machine. The connectivity pack and the motion control must be the following versions as a minimum: connectivity pack 1.5, SwissNano, CT 20, Swiss GT 26 motion control: 412 and Swiss ST 26 motion control: 28U.

The ISO code editing function and the tool catalogue management function are only available for the following five machines: SwissNano, Swiss ST 26, Swiss GT 26 & Swiss GT 13 and CT 20.

OS compatibility:	Windows XP, Vista, 7, 8 and 8.1 (32-/64-bit)
Recommended screen size:	WGXA (1280 x 800 pixels)
Random Access Memory and Hard Disk Drive:	RAM 2 GB, HDD 300 MB



official site, multilingual interface in FR, DE, EN and other languages, customer access (via secure login) to: activate and manage TISIS licences or to sign up to the information bulletin: available updates with new features, etc.

If you have not yet purchased TISIS software, it is possible to download it from the webstore <http://store.tornos.com> and benefit from a free 30-day trial.

And what about the future?

TISIS is currently available for the Android platform but many machine users do not have peripherals which run using this standard. Mr. Neuenschwander, the project manager, told us: *“Version 1.6, which will be unveiled before this year’s EMO, will be multiplatform: Android, iOS and Windows Phone”.*

Diagnostics

In the machine supervision section, a new page of information has been added to complement the monitoring functions, namely a diagnostics page. For each tool system (or channel), the following information is given: for each axis, the load and the temperature, and for each spindle, the load, temperature and actual speed.

Please note: This function is only available with the connectivity pack.

For more information about TISIS, please contact your usual Tornos distributor or Mr. Neuenschwander directly at the address below:

TISIS WebStore

The design and functions of the TISIS website have been updated. Here are a few developments: New graphic design to link it to the relation company’s



TORNOS

Tornos SA
 Patrick Neuenschwander
 Software Manager
 Rue Industrielle 111
 2740 Moutier
 T +41 32 494 44 44
 F +41 32 494 49 03
 neuenschwander.p@tornos.com

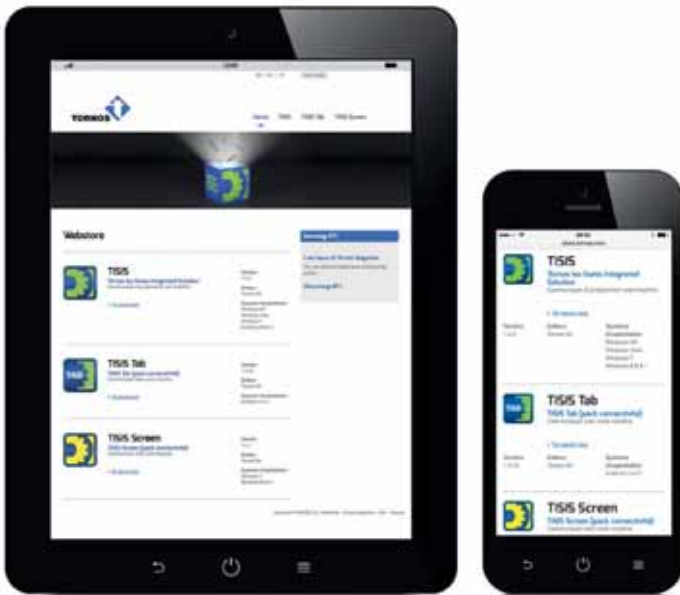



OPENING UP NEW MARKETS WITH THE SWISSNANO

Already equipped with some 50 automatic turning machines (including 15 Decos, 1 EvoDeco from Tornos and 32 Escomatics) the Swiss company Polydec has been working with a SwissNano machine for year... and it is only a lack of space that is stopping it from purchasing more.



To find out more, we met with Claude Konrad, CEO, and Domenico Di Iullo, CNC bar turning manager. Operating mainly in the automotive, watchmaking and electronics sectors, the company wanted to purchase a machine which could meet the requirements of Swiss watchmaking and work within the constraints of this industry. *“With the SwissNano, we have found a Swiss Made machine that meets our requirements”* begins Mr. Konrad.

Micron-level precision...

The constraints of the watchmaking sector are constantly increasing, especially in terms of precision. The workshop manager explains: *“We have always*

been very pleased with our Deco machines, but they are getting quite old now. Our comfort zone on these machines is around 4 microns, but nowadays we are often required to produce within a tolerance of 2 microns. The SwissNano makes this much easier.”

... with consistency

In Bienne, the machines are in production 24/7. How would you describe the SwissNano’s performance? Mr. Di Iullo is very satisfied: *“The results are excellent, the precision is perfect and the dispersion is very low. After a change of setup, the machine does not need to be preheated, the first part comes*

out perfectly and precision is consistent throughout production.” He adds: “Because the machine is very rigid, it produces excellent finishes and tool wear is minimal.”

An efficient design

Although the CEO appreciates the attractive design of the machine, he is convinced that the success of the SwissNano’s design is also due to its ergonomics and the quality of the machine itself: “The advantage of the SwissNano is its ergonomics – it offers a fully integrated solution. Moreover, it is well-designed, perfectly clean and watertight.” And these aspects are particularly important in a workshop like the one at Polydec. The 80-cm gap between machines soon becomes insufficient if the machines are equipped with devices which extend beyond the body of the machine.

Choosing the most suitable machine

For CNC bar turning, Polydec has Deco machines with nine axes, to produce complex parts, and other machines to produce simpler shaped parts. The SwissNano machine integrates both: it combines complexity of parts with greater precision. In the words of Mr. Konrad: “If SwissNano machines had been available a few years earlier, we would probably have more now.” For new parts, choosing a machine is simple; for very precise watch parts, the first-choice machine is the SwissNano, then the complexity determines if it is possible. Mr. Di Iullo finishes by saying “The specialists at Tornos told us that the aim of the SwissNano is to cover 80% of



Domenico Di Iullo, CNC bar turning manager

Dossier



needs in the watchmaking sector. Obviously, sometimes we would like to have more options, but the machine offers an excellent compromise."

What about watch parts?

The first parts produced are pins in three diameters with a tolerance of just a few microns, then there are the double plates, the setting pinions and other parts. These are all finished on the machine, including those which need hobbing and stamping operations. The CEO explains: *"Nowadays we can produce parts which were beyond our means before the arrival of the SwissNano. It has really opened up new markets for us."*

Highly targeted possibilities

During the visit, we discover a short part featuring a special kind of machining in the centre. To create it, Polydec uses the bushless operating mode and stamps the part in the centre. It is quick and simple to switch from standard machining with a fixed guide bush to bushless machining. The machine's simplicity is another advantage appreciated by the micro bar turning specialist from Bienne.



POLYDEC SET TO RELOCATE IN 2015

To pave the way for growth, Polydec has acquired new industrial premises in Bienne. These much larger premises will enable the company to increase its production capacity. Due to the conversion, the relocation is planned for the end of 2015.

Located right next to a large well-known watchmaking group, the company's former premises are perfectly placed and well-equipped for a bar turning workshop and are for sale (more info available on the company's website: <http://www.polydec.ch/fr/actualites/batiments-a-vendre/>)



Simple and intuitive to use...

The workshop manager appreciates how simple the machine is to set up and use: *"Although the tool systems are not as modular as on the Deco, the setup is simple, and quicker. Even special operations such as hobbing or stamping pose no problem."* Another advantage is that the machining area can be accessed from all sides, although in practice it is rare to need access from the back. The size of the machine also makes it great to use: *"it is very compact and at a perfect height for us. The housing is watertight and everything is integrated"* adds Mr. Di Iullo.



... with perfect programming

The workshop manager explains: *"We are used to TB-Deco and ISO programming with TISIS: Tornos offers a tool which combines both. It is an advanced editor which enables us to perform classic ISO programming but which also offers us information and help inspired by the best TB-Deco tools"* (on this topic, see the article presenting version 1.5 of TISIS on page 25).



And what is more, the service is excellent!

When asked about the service offered by Tornos for the SwissNano, the managers were very pleased: *"We have had to contact the after-sales service two or three times and we have nothing but the highest praise. They helped us quickly and skilfully."*

In conclusion, the managers added: *"It's always easy to criticise and to comment on what is not right, but since everything is fine and we are very satisfied, there is not a great deal to say. That's how it is with the SwissNano!"* Once their relocation project is complete (see box), it is highly likely that Polydec will equip its workshop with other SwissNano machines.



engineering and manufacturing
to fit your needs

Polydec SA décolletage
Rue de Longeau 18
CH-2504 Biel/Bienne
Tel. +41 32 344 10 00
Fax +41 32 344 10 01
polydec@polydec.ch
www.polydec.ch

The present

7TH TORNOS JOURNÉES HORLOGÈRES OPEN DAYS

A HOTLY ANTICIPATED EVENT

Every year, a few weeks before Baselworld, specialists in watchmaking machining come from Switzerland, southern Germany and France to attend the Tornos Journées Horlogères open days, where they are able to discover new products, get advice and make purchases. In 2015, this hotly anticipated event will take place at the company's premises in Moutier from the 3rd to the 6th March.



Brice Renggli, marketing manager, explains: *“During the event, we present complete watchmaking solutions and all of our specialists are on hand to chat with customers. This allows us to offer customised solutions while consolidating our expertise in the field - it’s a win-win situation.”*

A range dedicated to watchmaking solutions

Tornos has been supplying solutions to the watchmaking industry since the start of the last century, and its machines are most likely present in the vast majority of bar turning workshops producing

components for this sector. The company offers machines adapted for watchmaking to resolve its customers’ problems. Let’s take a look at some of the products:

SwissNano

“The SwissNano is used by many of our watchmaking customers, and has become an important machine for them thanks to its high precision, ergonomics and ability to produce 80% of the components found in a watch movement”, reveals Mr. Renggli. This small machine designed by Tornos

has a surprising capacity for maintaining dimensional precision during production. The manager continues: *"We knew that the machine had a good pedigree, but the results reported by our customers have strengthened this positive impression even further."* (you can read the SwissNano success stories at decomag.ch)

EvoDeco 10

During the Journées Horlogères open days, visitors will be able to discover the new version of this well-known machine. *"The machine can be equipped with three hobbing systems, which means we can produce the most complex watch parts,"* adds Mr. Renggli. One distinctive aspect of the Journées Horlogères open days is that the exhibited machines are all running, and the company's commissioning technicians are on hand to discuss their various features. On the subject of the EvoDeco, Mr. Renggli concludes: *"For customers wanting to produce larger diameter parts such as the balance, we also offer the EvoDeco 16."*

MultiSwiss

For high-volume applications, the company has offered the MultiSwiss since 2011, to the satisfaction of the manufactures. The proof? The major watchmaking groups rely on the characteristics of this machine. In the words of Mr. Renggli: *"We can perform hobbing operations and the machine also has a Y axis."* For example, the MultiSwiss machine can be used to finish parts such as barrel drums and arbors, and customers have also been delighted with the geometric and dimensional performance in these operations. The manager adds: *"The characteristics of the MultiSwiss, in particular the hydrostatic technology, allow us to create finishes that satisfy watchmakers' requirements."* The machine has been used to replace a set of cam-controlled turning machines with hobbing machines. The footprint and repeatability gains are unparalleled.

Swiss GT 13

"The new Swiss GT 13 is the best combination of productivity and high feasibility, to be available on the market" explains Philippe Charles, product manager, by way of introduction during our meeting to find out more about this new machine.

Almac BA 1008

During the Journées Horlogères open days, two versions of the Almac BA 1008 will be on show: one with a bar feeder and one equipped with a special profile clamping system and a kit for machining



EvoDeco 10 – see article on page 7

MultiSwiss – see article on page 23

Swiss GT 13 – see article on page 11

Almac BA 1008 – see article on page 15

THE RULES GOVERNING SWISS MADE WATCHES

process to reinforce the Swiss Made watch concept. This involved a change to the ordinance governing the use of the term "Swiss" for watches, more commonly known as the Swiss Made ordinance.

The aim of this process was threefold:

- to guarantee the credibility and value of the label over the long term
- to guarantee the satisfaction of consumers who, when purchasing a Swiss Made watch, expect it to be made in Switzerland and incorporate a high level of Swiss added value
- to close a legal loophole and more effectively combat abuse of the label

The main change brought about by the reinforcement project was to specify a minimum value for the watch itself, and no longer just for the movement. Hence, in order for a watch to be stamped "Swiss Made", it would have to meet the following requirement:

- a minimum of 60% Swiss value for quartz watches
- a minimum of 80% Swiss value for mechanical watches

The existing requirements, such as the inclusion of a Swiss movement, casing up and final testing in Switzerland were also retained. However, the definition of the Swiss movement was also changed to at least 60% Swiss value (as opposed to the existing 50%).

New criteria have been added to the calculation of Swiss value, such as the costs of research and development or certification.

The new wording will come into force at the same time as the new legal basis for Swissness, no earlier than 2016, while setting a transitional period to allow producers to adapt to the new legislation.



precious metals. This small milling centre will also feature the Ecopack, a set of functions designed to save energy.

Swiss Made: an advantage?

Almost all of the machines on show at the Journées Horlogères open days are produced in Moutier and La Chaux-de-Fonds - is this important for the watchmaking market? The manager makes it very clear: *"What is most important is that our products maintain the reputation for high precision and quality earned not only by Swiss Made products, but also by the Tornos brand."* Paradoxically, the Swiss Made label is probably more valued abroad than in Switzerland, but the label is still clearly an asset, and Tornos is particularly conscious of this as even its machine ranges made in Asia include strategic parts produced in Switzerland.

The Journées Horlogères open days - an annual event not to be missed

As in previous years, the watchmaking industry is invited to discover new products and expertise specific to Moutier. Mr. Renggli concludes: *"Our specialists will be delighted to share their passion with visitors and to help them find solutions to facilitate their production of parts worthy of the Swiss Made label - that's our commitment."*

7th Tornos Journées Horlogères open days

Moutier Techno-Center
From 3rd to 6th March 2015
From 9 am to 6 pm



EVODECO IN THE SERVICE OF HEALTH

The department for implant screws at Stryker in Selzach has more than 32 Tornos machines, two of which are the new EvoDeco 20. Three more of this type of machine have already been ordered and should contribute to the production of the millions of screws which this specialist company manufactures each year. We wanted to find out more, so we met with Roland Urben, the Production Manager for Implant Screws.



Daniel Gerber, CNC Mechanic.

The two EvoDeco machines have been in operation for a little over a year. Stryker planned for these machines to produce the parts that had until then been manufactured on the Deco 20, but also to enable the development of new parts. Was this goal achieved?

The right machine for every task

Stryker has an extremely comprehensive machine inventory, equipped with machines from a variety of well-known manufacturers. We asked Mr. Urben about the decisive reasons for manufacturing certain parts on the Deco and EvoDeco: "We constantly strive to select the most suitable machine for each part we produce, in terms of both technical and

economic considerations. The Tornos machines are, without question, the most precise in our machine inventory, which is why we use them for the most demanding parts." On the economic side of things, Mr. Urben has no doubts: "Tornos machines are currently very competitive as regards return on investment."

An astounding development

As a specialist well-acquainted with the old Deco 20 and the new EvoDeco 20, Urben states that: "The Deco 20s were already extremely precise, and the new EvoDeco 20s operate with at least the same level of precision. We found that the biggest difference between the two generations of these



machines is that the new machines are significantly more robust. In addition, the EvoDeco is much easier to operate and is also quieter, which is an advantage for our operators which should not be ignored. The ability to access TB-Deco directly from the machine simplifies things a lot and so is also much appreciated."

TB-Deco? A powerful tool

Since the launch of the first Deco machines in 1996, the TB-Deco software has made a name for itself in the sector. But what does Mr. Urben think about the system? *"There is a completely different philosophy behind it, which makes things somewhat difficult for beginners. However, once you master the software, it is a very efficient and easy-to-use tool."* Most Stryker employees are assigned to a specific brand of machine, but some specialists can also switch between TB-Deco and the classic ISO system used by other machines. On the subject of manufacturing parts with the help of CAD systems, Mr. Urben states: *"We manufacture many different types of part here, but everything is to do with screws, so we don't need that type of programming system. TB-Deco easily meets all our needs when it comes to the Tornos machines."* At Stryker, one operator is in charge of several machines at the same time.

The first two EvoDeco 20s ever

"Tornos supplied us with the first two EvoDecos ever made, and, despite a few small teething problems, we were immediately able to work productively using the machines," Mr. Urben explains. He continues: *"The quick commissioning of the machines and the excellent service by Tornos cannot be emphasised enough."*

More and more complex parts...

Even though established implant materials such as titanium and stainless steel are used to manufacture the screws, the challenges presented in terms of geometric and dimensional precision require machines whose performance can consistently keep up with requirements. Mr. Urben is very satisfied with the EvoDeco in this regard: *"The options which Tornos has specially developed for the medical sector, such as high-pressure drilling, thread whirling or hexalobular internal milling (Torx), enable us to carry out all required machining steps."* Depending on the circumstances, Stryker have developed their own macros or turned to the specialists at Tornos. The final aim is always, of course, using the machine to completely machine a workpiece.



The "Advanced Operations" department

Alongside its department for the production of surgical screws, Stryker also operates a centre for development and prototype manufacturing, which is able to rely on the services of an EvoDeco. *"Thanks to the versatility and performance of the EvoDeco, particularly for milling and cutting, we were able to develop new screws and new processes. During the planning and development of new parts, we are engaged in a constant dialogue to ensure not only that we are able to deliver parts which precisely meet requirements, but also that we make optimal use of the possibilities and capabilities of the machine, enabling us to optimise our production,"* Urben states.

... and unwavering reliability

Operators at Stryker work in shifts and the machines typically run around the clock, five or six days a week. Urben is full of praise: *"The EvoDecos are extremely reliable and robust, so we can implement small- to medium-sized production runs, depending on the type of screw, without any concern. And when we need it, we know that we have a capable after-sales service we can rely on."*

A remarkable after-sales service

"In recent years, Tornos has been working constantly on improving its after-sales service, and we are now very satisfied with the results. Their reaction time is outstanding and the solutions they suggest are always suitable," Urben adds. A Tornos technician was also at the site during our visit. He was called out at around 7 a.m. due to a technical problem, and arrived less than two hours later, while Mr. Urben was showing us around the facility.



STRYKER IN BRIEF

The Stryker Corporation is one of the leading companies worldwide in the orthopaedic sector, and one of the most important manufacturers of medical equipment. Stryker offers an extensive range of products, including: Joint prostheses, trauma implants, vertebral implants, products for orthobiologics, electrical motors, surgical navigation systems and endoscopy equipment as well as trolleys and devices for emergency wards. Stryker has more than 25,000 employees and operates in more than 100 countries, with a turnover of more than nine billion dollars.

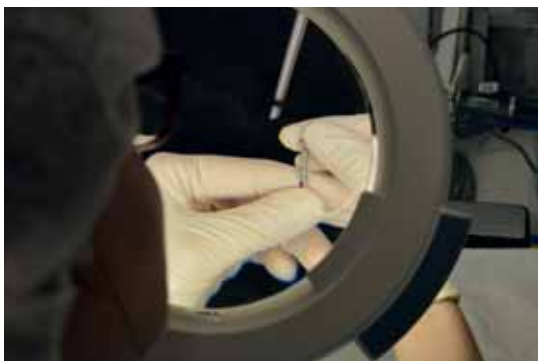

Spare part database? A great help

When asked to give more details about the services offered by Tornos, Mr. Urben added: *“Another ingenious aspect of Tornos’ services is the spare part database, which is available online for all of our machines. With its help, we are able to quickly find and identify the parts we need and directly order them using a secure system. Even during the ordering process itself we have transparent information about the stock which Tornos has available and delivery times.”*

An association with a long tradition

“We have been using solutions from Tornos from the beginning and the number of their machines we have is always growing, because the machines they offer are always the appropriate response to the constantly increasing demands of the market. The next stage is the delivery of the three new EvoDecos,” he concludes.

The goal has been achieved

Stryker has fully achieved its goal of replacing the ageing Deco 20s (which have more than 40,000 operating hours) and developing new processes to manufacture surgical screws more efficiently with the EvoDeco. Even if machining the screws on the automatic turning machines is only the first stage of a long production chain, it remains the basis for producing the universally recognised Stryker products.

stryker[®]

Stryker Trauma AG
Bohnackerweg 1
CH-2545 Selzach
Switzerland
www.stryker.com

EXTRAORDINARY EXPERTISE

For several years, Tornos has mainly targeted its communications towards four business areas: automotive, watchmaking, medical and electronics. To coincide with the publication of the 2015 issue of the industry brochures, we met with marketing manager, Mr. Brice Renggli, to find out a bit more.

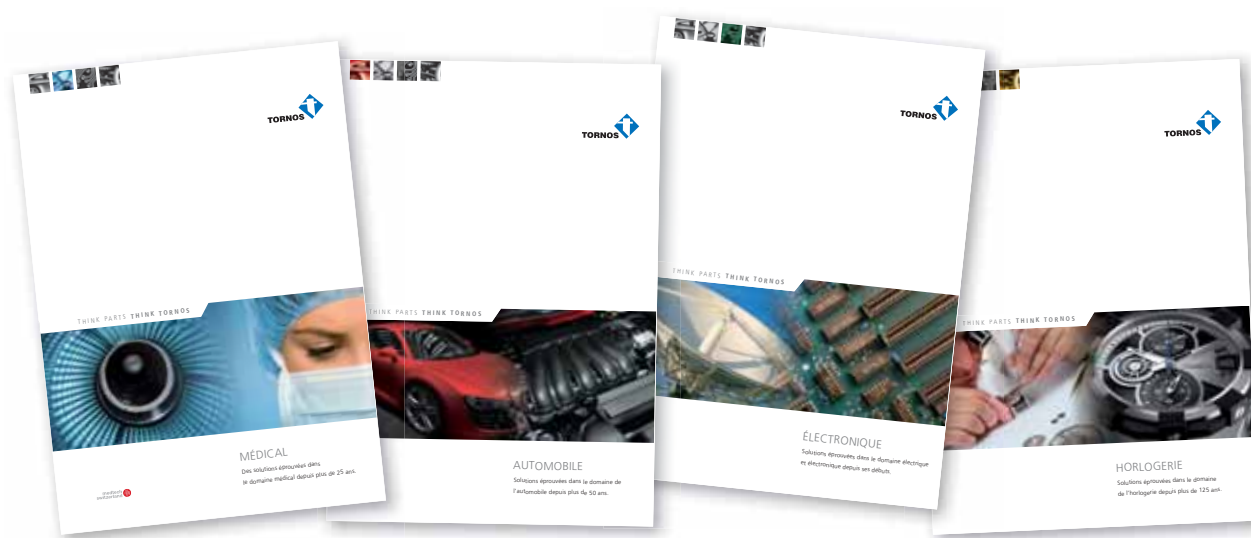

The four above-mentioned brochures have been extensively revised to take account of the company's most recent expertise, but what is the purpose of these documents? *"In the company's history spanning over 100 years, Tornos has always developed customized solutions for these different sectors, and these documents provide our customers with evidence of this"* explains Mr. Renggli, by way of introduction.

An ever-changing world

Although the key principles of bar turning have not fundamentally changed since 1880, everything else is changing constantly and rapidly. Whether it is a question of the materials to be machined, the capacities of tools and their coatings, the complexity of parts, specific applications or machine-tools combining all these changes, users must stay abreast of developments to remain competitive.

Technical centres as close as possible to the market

As each innovation leads to others in the various machine-related areas, manufacturers offering specific solutions quickly find themselves facing many

challenges. Within the Tornos group, each subsidiary has its own "Techno-Center", just like the parent company in Moutier. These centres are mainly equipped with single-spindle and multi-spindle machines for performing tests for customers or other tests relating to the aforementioned developments.

An unparalleled knowledge database

Therefore, there are potentially hundreds of new applications presented each year to the various company specialists across the globe. *"We immediately met with the problem of having to avoid duplicating work; with the requests for quotation being increasingly globalised, it is not uncommon for parts to be ordered from various locations"* explains the manager. The solution? Set up a global database to log all the developments and all the setups. This knowledge database can now be used by all the Swiss group's customers.

Customized support and targeted responses

Benefiting from the knowledge and expertise of Tornos specialists, at the click of a mouse, enables them to respond more quickly and in a highly targeted way. Whether it be support relating to

The present



FOUR BROCHURES FOR FOUR KEY AREAS

When asked about the distribution of company turnover, the Tornos manager replied that the distribution varied from year to year, but that the Group's communication tools corresponded to the four main areas: automotive, medical, watchmaking and electronics. It is well-known that many customers work in other sectors such as nuclear, telecommunications or consumer products, but as Mr. Renggli says: *"We cannot produce a brochure for each specific development, but our expertise also extends to these applications."*

machines, devices, tips, technical advice or even advice relating more broadly to their business areas, our customers have access to the information and test results they need. Mr. Renggli adds: *"There are many dozens of machine manufacturers operating on the market, but none can boast of having the same expertise as Tornos. In the watchmaking sector for example, we have been developing bespoke solutions now for 100 years... and we are still driven by this desire."*

Managers for each field

And if this database and the specialists using it were not sufficient to respond to all the challenges of our customers, Tornos also offers them the chance to contact the business area managers who can advise them further. These professionals have been operating in their fields for many years and constantly



stay abreast of changes in their business areas. Mr. Renggli explained: *"It is not uncommon for our business area managers to help our customers on specific points e.g. control, SPC or even standards."*

New brochures? Gateways

Mr. Renggli concludes: *"Our expertise is extensive and made available to our customers, particularly via our centralised database and our specialists. We have produced these different brochures to enable our existing customers and potential new customers to discover that Tornos offers much more than just machines; by purchasing a Tornos machine, users will also benefit from cutting-edge expertise in the various key business areas in the bar turning industry today."*

The new brochures for each business area are available for download from www.tornos.com/download.

Do you need advice on an application, a machining technique or a specific field? It is highly likely that the specialists at Tornos have the answer you are looking for! They are available worldwide and will respond quickly to your requests.



Tornos SA
Industrielle 111
2740 Moutier
Tel. +41 32 494 44 44
Fax +41 32 494 49 07
www.tornos.com

WE LET OUR CUSTOMERS DO THE TALKING...



www.partmaker.com/video/integral/

... HEAR WHAT THEY HAVE TO SAY

“With PartMaker, we have much better utilization of our programmers, our set-up people and our operators. Some things that were being sent off shore are coming back because we can do them more efficiently. PartMaker has helped us bring in more business and cut down on our costs as well.”

Peter Reypa | President
Integral Machine | Oakville, ON Canada

certified for Deco [a-line] by



Use PartMaker to program the following Tornos machines:

- * Tornos DECO Series
- * Tornos EvoDECO Series
- * Tornos Sigma Series
- * Tornos Gamma Series
- * Tornos Delta Series
- * Tornos Micro Series



Advanced
Manufacturing
Solutions

PartMaker

A Division of Delcam Plc

Contact us today to learn how PartMaker can improve your productivity.

Pacific Design & Manufacturing
February 10-12, 2015 | Booth #4146
Anaheim Convention Center, Anaheim CA

Houstex
February 24-26, 2015 | Booth #1141
George R Brown CC, Houston TX

Ph: 215-643-5077 | Toll Free: 888-270-6878 | Email: info@partmaker.com | web: www.partmaker.com

PERFECT PROFILE.

zeus® Knurling Tools stand for process safety.



HOMMEL
KELLER PRÄZISIONSWERKZEUGE

Whether standard or individual special solution: As global market leader in the field of Knurling Technology we offer you the highest quality and process safety for your workpieces.

Play it safe.
Phone +49 74 24/97 05-0

Hommel+Keller
Präzisionswerkzeuge GmbH
D-78554 Aldingen
www.zeus-tooling.de



The premium brand
of Hommel+Keller



SUCCESS STORY WITH THE TORNOS CT 20

Reputed Electric Industrial (Shenzhen) Co., Ltd was established in 1984. The factory is located in Guanlan, Shenzhen, and is set over 50,000 square meters. The company has around 650 employees, annual sales of 48 millions USD and mainly produces audio and video plugs, connectors and IT parts. The company works with 577 lathes in total, including 123 CNC lathes from a range of brands.



Fully-integrated production

Reputed Electric Industrial mainly manufactures audio and video connectors and plugs. These products are very small and are formed of several complicated, precise parts. In order to achieve the perfect production scale with advanced production technology, the specialists at the company are continuously setting up different processing departments, such as lathes, punches, electroplating injection, CNC, line cutting, engineering and inspection departments, to ensure the quality, cost and lead time of products.

"We can offer to develop new products for customers at the same time" says the company's spokesman.

Tornos CT 20 to complement the pool

The existing CNC lathe has been in use for about 10 years. Because of the rapid change in customer requirements, advances in technology and product diversification, the existing equipment no longer fulfills its purpose well. In view of this, Reputed Electric Industrial restructured its CNC department

Presentation



TORNOS CT 20 – CHARACTERISTICS

Powerful, robust bar turning machine

Main advantages

- Highly rigid and stable cast iron frame
- Modular tooling system
- Powerful spindles and drives
- Quick, easy configuration
- Intuitive
- ISO programming

Maximum diameter	20 mm
Number of linear axes	5
Number of C axes	2
Number of independent tool systems	2
Total number of tool positions	26
Position for rotating tools	10

and, at the same time, purchased 2 Tornos CT 20 machines for the production of samples in October 2014. Its 5-axis system can cater for the needs of small, complex products and improve the quality of existing products manufactured by Reputed Electric Industrial. Tornos provides staff training and the CT 20 is easy to operate; it has been formally added to the production line and has produced samples for clients.

A perfect fit

The company's spokesman says: *"The outcome is highly satisfactory, both the processing speed and precision meet our expectations. We are ready to purchase more equipment if the customer is happy with the samples and wants mass production to start"*.



Reputed Industrial
Company Limited
Block A, 9/F,
Hoi Bun Industrial Building,
No.6 Wing Yip Street,
Kwun Tong, Kln, H.K
Tel: 852-23897307/8
Fax: 852-23436176
www.reputed.com.hk

Reputed Electric
Industrial (SZ) Limited
No.72 Guanlan Road,
Zhuyuan Industrial Zone,
Guanlan Town,
New Longhua District,
Shenzhen, China
Tel: 0755-27985441 27985449
Fax: 0755-27985156 27999662
www.reputed.com.cn



DIBA INDUSTRIES ELIMINATES BOTTLENECK WITH TORNOS

When Diba Industries identified a bottleneck in its machine shop that produces connectors, fittings and adaptors for the fluid handling industry, it found the solution with a Tornos Delta 12/5 turning centre.



As a market leading provider of innovative solutions to the most demanding fluid path applications for the clinical and scientific sectors, Cambridge based Diba has a turning section that was witnessing bottlenecks created by a relatively unproductive single spindle turning centre that required a full time operator for programming, loading and un-loading the machine.

Already a user of other sliding head turning centres with 16 and 32 mm diameter capacity machines, the first point of contact for Diba was its existing supplier. However, the only machines available proved over specified and too expensive, so Diba reviewed the Tornos range. Commenting upon the reasoning behind buying the Tornos Delta 12/5 that was installed in September 2013, Engineering Project Manager at Diba Industries, Mr. Paul Wright comments: *"We wanted to replace the single spindle machine with a more productive twin spindle to eliminate the bottleneck where we produce parts under 16 mm diameter. New machines from our existing supplier had too many axes and features and were therefore overpriced for what we*

required. Whilst Tornos equally have high end turning centres, the Delta proved a perfect fit for our parts as it had the right specification at the right price. What sealed the deal for us was the guide-bushless running on the Tornos that reduces the bar remnants and the associated waste at the end of each bar."

Turning expensive materials such as PEEK and PCTFE, Diba was previously left with 250 mm remnants from each bar - a waste rate of almost 10% per bar. The guide-bushless system on the Delta has cut this waste rate by upto 60%, which equates to a 4% overall saving on material costs.

From a productivity perspective, the Delta 12/5 has reduced some cycle times from four minutes down to 1 minute per part. This cycle time saving of 3 hours a day or 60 hours a month is partially down to the twin-spindle set-up that completes each part in one-hit as opposed to additional set-ups on the previous single spindle machine. The benefit of completing parts in one operation on the Delta 12/5 has improved component quality, consistency and overall accuracy. Furthermore, with a typical batch



Presentation

size of anything up to 500 parts, the barfed Tornos removes the need for an operator to constantly load the machine. As Mr. Wright continues: *"Our previous turning centre had to be manned almost permanently, whereas our other machinists set-up and run a number of machines simultaneously. The arrival of the Tornos has freed up our operator to also simultaneously run other machines."*

Whilst the ability of the Tornos to deliver up to a 75% productivity improvement over a single spindle machine is impressive, the Delta 12/5 has also absorbed some of the workload from the sliding head machines at Diba. Here too, Diba has witnessed cycle time improvements. The kinematics of the Tornos with tooling positions close to the workpiece has improved productivity and cycle times by an average of 10% over the existing and more expensive sliding head machines.

Highlighting other benefits of the Tornos installation, Mr. Wright says: *"As a first time Tornos customer, we are delighted with how easy the machine is to program and set-up. The barfeed integrates with the machine perfectly and it is easier to conduct bar diameter changeovers than our other machines. The set-up times are drastically reduced,*

which is ideal as we may run two to three different jobs each day on the Tornos. Running upwards of 500 parts and then re-setting the machine for the next job; the Tornos is extremely well developed for flexible production schedules like ours. Additionally, the Delta 12/5 has high pressure coolant and this has been a revelation in managing the long string like swarf that is commonplace with the materials we machine. On the whole, we are delighted with the Tornos machine."



Diba Industries Ltd
2 College Park,
Coldhams Lane,
Cambridge, CB1 3HD, UK
Tel: +44 (0) 1223 472801
Fax: +44 (0) 1223 416787
sales@dibaind.com



REFILL IT! MOTOREX MINI SPRAYS

Spray like the big boys: Take compact, refillable Mini Sprays with you and use them anywhere – The perfect addition to the Motorex spray range.



Motorex developed its versatile Hi-Tech sprays for daily professional use. If you just need a little, but it has to be handy at all times, the new Mini Sprays are just the thing.

Motorex refill system

The idea for Mini Sprays, which can be refilled as often as users want, stems from the fact that large (500 ml) spray cans are not always convenient to

use. Each Mini Spray kit consists of three empty 50-ml spray cans. Each can has a base label, and the package contains a sheet of self-adhesive labels for the most commonly used sprays from the Hi-Tech range.

Now any user can put together a personalized set of the sprays they use most often. Just choose the right label from the sheet and apply it to the space

The present



Handy in any situation.



Takes up very little space.



Extremely versatile.

intended for it on the Mini Spray. The refillable Minis are filled straight from the large standard spray can, which functions as a dispenser. Just place the empty Mini Spray on a firm, level surface, remove the spray nozzles from both cans, shake the dispenser and fill the small spray.

Always at hand

Many users told Motorex how inconvenient it can be to carry a large spray can while assembling equipment or working in cramped spaces. The company responded by introducing a refill system for its nine most popular Hi-Tech sprays.



FILL UP IN A JIFFY

Create your own practical Mini Sprays in just a few steps.

1. Take an empty can from the Motorex Mini Spray package.
2. Choose the product you want and apply the appropriate label to the Mini Spray.
3. Remove the lids and spray nozzles.
4. Shake the large original spray can.
5. Place the empty Mini Spray on a firm, level surface and fill it for 30 seconds.
6. Attach the spray nozzle and lid and you're done!



100% Swiss made by Motorex

All Motorex sprays are developed in Langenthal, tested in professional real-world practice and then produced at our own production facilities. This approach enables Motorex to offer the right spray for every application.

Try refillable Mini Sprays now!



Motorex AG Langenthal
Aftersales Dept.
P.O. Box
CH-4901 Langenthal, Switzerland
Tel. +41 (0)62 919 74 74
Fax +41 (0)62 919 76 96
www.motorex.com

PERFORMANCE | PRECISION | RIGIDITY



APPLITEC

SWISS TOOLING

Applitec Moutier S.A. | Ch. Nicolas-Junker 2 | CH-2740 Moutier | Tél. +41 32 494 60 20 | Fax +41 32 493 42 60

www.applitec-tools.com